

EW

EDGEWATER  
RESIDENCES

**PHASE 3**

Premium Seaview Living

---



An aerial photograph of a beach with turquoise water and white foam. The water is a deep, vibrant blue, and the foam is a bright, creamy white. The beach is a mix of light and dark sand, with some darker patches visible. The overall scene is serene and beautiful.

UNLOCK TRANQUIL  
*seaside lifestyle*

Step into a world of elegance and serenity at **Edgewater Residences**, where modern sophistication meets waterfront bliss. With breathtaking views of the sea, this exclusive community offers an unparalleled lifestyle in the heart of **Dubai Islands**.



UNMATCHED  
LIVING EXPERIENCE  
*in the heart  
of Dubai Islands*

**Prime location**

with direct access to the sea

**Vibrant lifestyle hub**

featuring shopping, dining, and entertainment

**Exclusive amenities**

including clubhouse, wellness zones, lush  
landscapes, and even more



# MGS DEVELOPMENT

Edgewater Residences is created by **MGS Development**, a renowned real estate company dedicated to delivering world-class residential projects. With a commitment to excellence, innovation, and sustainability, the developer has earned a reputation for creating luxurious, future-forward living spaces that redefine modern elegance.

## AYENK

As a key partner in this landmark project, renowned American architects **AYENK** based in Miami, Florida, have brought their expertise in luxury waterfront design, ensuring a perfect balance of sophistication and serenity.



# DUBAI ISLANDS — THE NEXT *icon of Dubai*

**Dubai Islands** — a luxurious 17-square-kilometer waterfront development by Nakheel Properties, the creator of Palm Jumeirah. This exclusive destination features **five unique islands** designed for a refined lifestyle, from a vibrant cultural hub and marina to premium beachfront living, championship golf courses, and ultra-luxury villas.

9

exclusive  
marinas

40 km

of new  
coastline

21 km

of sandy  
beaches

Over 80

world-class hotels  
and resorts

30,000+

residential  
properties



# Location

10 mins

Dubai International Airport

20 mins

The Burj Khalifa

20 mins

Dubai Mall

25 mins

Burj Al Arab

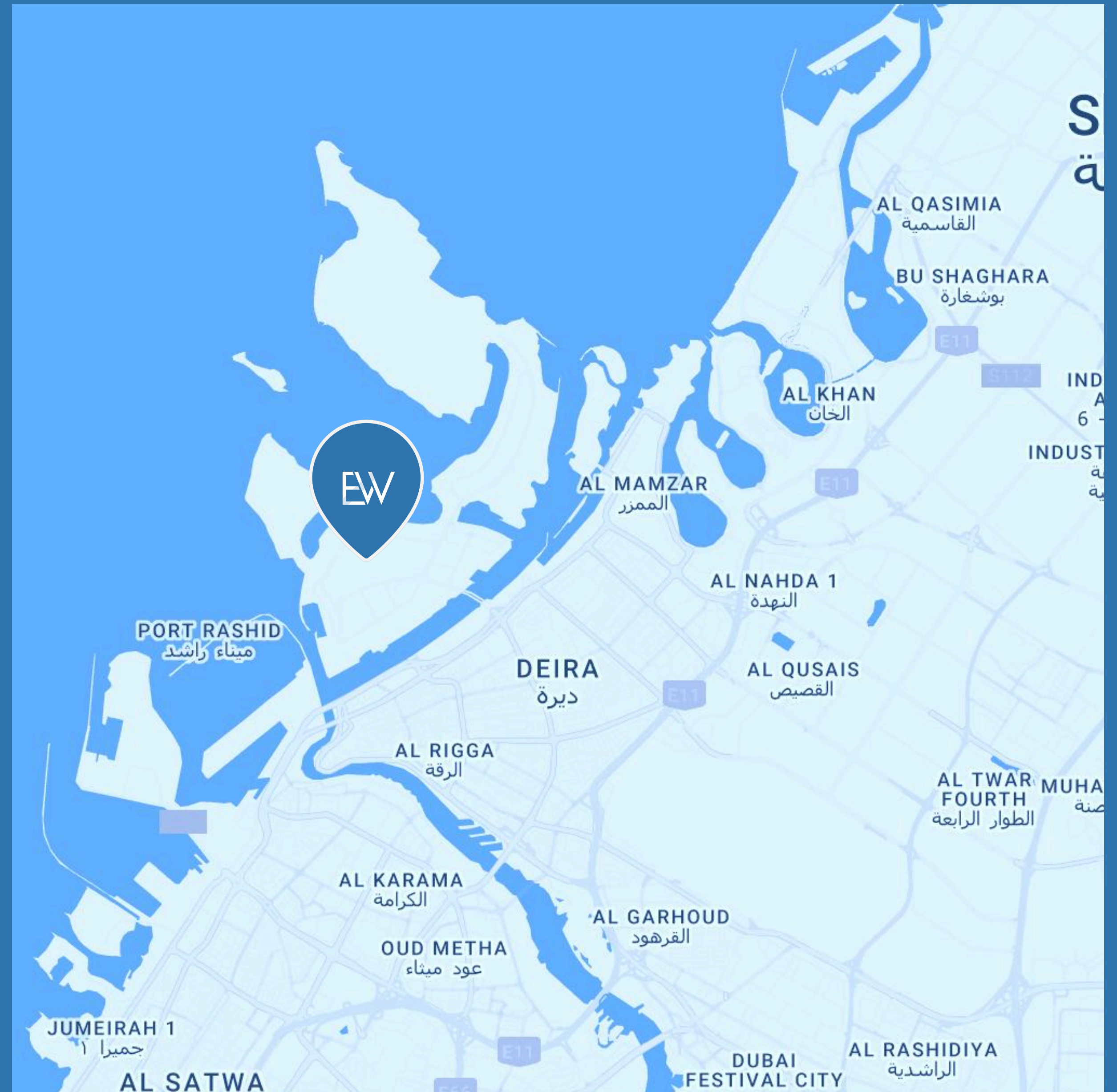



# *Why Dubai?*

## **Tax-Free Environment**

No income, capital gains, or inheritance tax.

## **Lucrative Rental Yields**

One of the highest ROIs in the world, typically between 5-9%.

## **Residency Visa**

Investors can obtain a 2-year visa or a 10-year Golden Visa, including sponsorship benefits.

## **High Quality of Life**

Ranked #1 in the MENA region and #6 globally in the World's Best Cities Index 2024 by Resonance Consultancy.

## **100% Safety**

Dubai is ranked the 4th safest city in the world in 2024, according to Numbeo.

# *About project*

Set on the serene Dubai Islands, **Edgewater Residences** reaches its pinnacle with Phase 3 — the final and most luxurious chapter of this prestigious development. Comprising three elegant 12-storey towers, this exclusive collection is designed for those who seek refined coastal living amidst lush greenery and pristine shorelines.



Located on the prestigious Shore Island, **Edgewater Residence** will offer luxury living with premium residences, resorts, marinas, golf courses, and wellness retreats.

Residents will enjoy fine dining, boutique shopping, and the upcoming Dubai Islands Mall, which is set to surpass Dubai Mall in size by 20%.



*Interior*

# Living Room



# Bedroom





# Bathroom



PREMIUM QUALITY FINISHES

# Entrance Hall



Walls  
Porcelain Slabs  
Size: 320x150 cm Surface  
Look, Polished

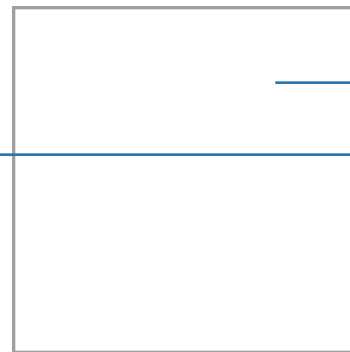

Ceiling  
Gypsum Board, Paint  
White Color

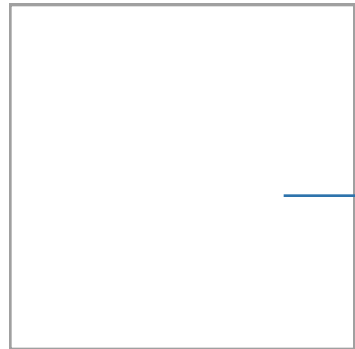

Walls  
Wooden Cladding,  
Painted MDF Wood

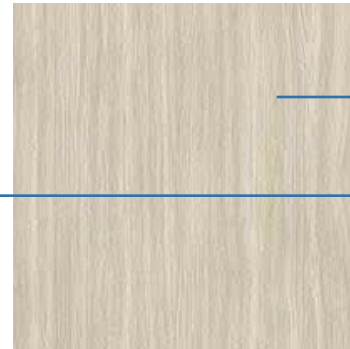

Walls  
Wooden MDF Cladding,  
Natural Veneer

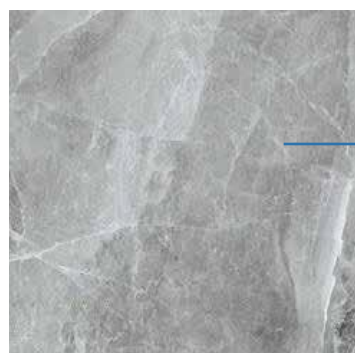

Floor  
Marble, Tiles  
Size: 120x120 cm Surface  
Look, Polished



Walls  
Jotun Paint, Light Grey





PREMIUM QUALITY FINISHES

*Lift Lobby*



Ceiling  
Gypsum Board, Paint  
White Color



Wall Cladding  
Black Glass Mirror



Wall Cladding  
Wooden MDF Cladding,  
Natural Veneer



Lift Doors  
Polished Dark Stainless  
Chrome

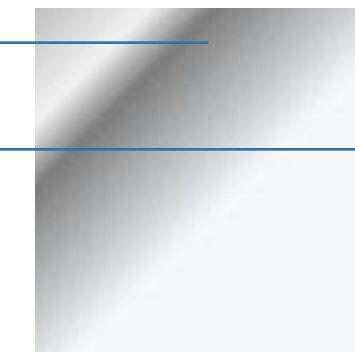

Wall Cladding  
Polished Dark Stainless  
Chrome

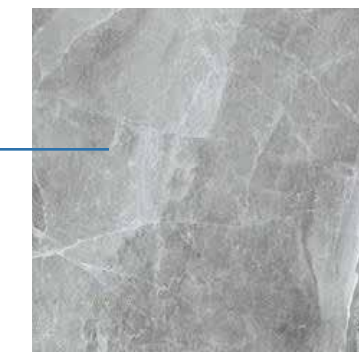

Floor  
Marble, Tiles  
Size:120x120 cm Surface  
Look, Polished

PREMIUM QUALITY FINISHES

*Typical corridor*

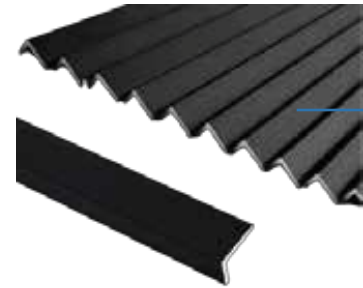

Horizontal Aluminum  
L Channel  
CRL SDCD516MBL  
Matte Black 5/16"  
Single Aluminum U  
Channel

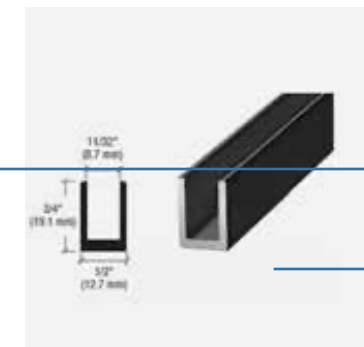

Vertical Aluminum  
U - Channel  
CRL SDCD516MBL  
Matte Black 5/16" Single  
Aluminum U-Channel

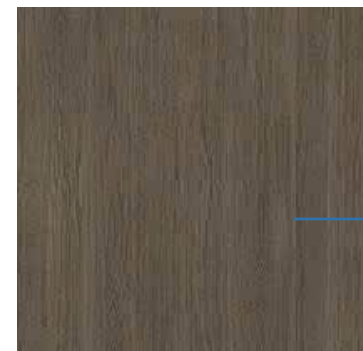

Corridor Doors  
Door Size: 220x100 cm  
Surface Look, Matt

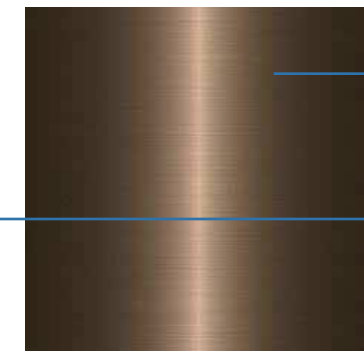

Bronze Metallic Platte  
Door Size: 100x10cm  
Surface Look, Matt



Wall  
Jotun Paint Stucco  
Effect

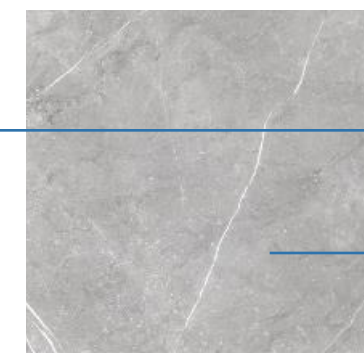

Floor & Skirting  
Porcelain, Size: 120x60  
cm Tiles Size:120x10  
cm  
Surface Look, Matt



PREMIUM QUALITY FINISHES

*Throughout apartment*

Living Room



Floor & Skirting  
Porcelain, Size: 120x60 cm  
Surface Look, Matt



Ceiling  
Paint White Color

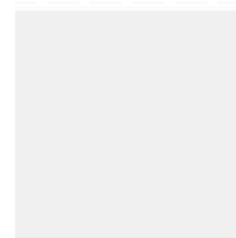

Walls  
Off White Color



Doors  
Laminate



Cabinet Doors  
Laminate

Kitchen



Countertop  
Engineered Stone



Wall  
Between  
Cabinet  
Porcelain



Wardrobes  
Doors  
Laminate

Bedrooms

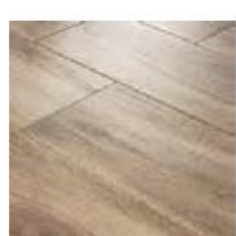

Floors &  
Skirting  
Porcelain



Ceiling  
Paint White  
Color

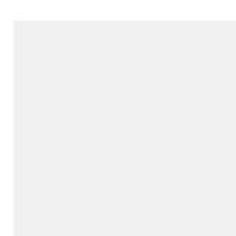

Walls  
Off White  
Color

Bathroom

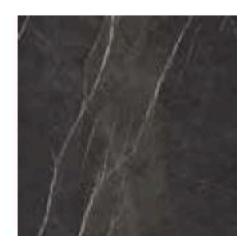

Tile  
Armani  
Grey

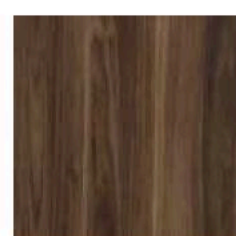

Vanity  
Countertop:  
Vanity Doors:  
Laminated HPL



Walls &  
Floor  
Porcelain Tiles

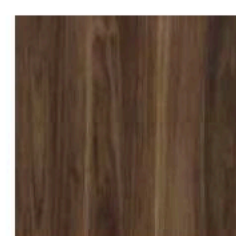

Wardrobe  
Laminated MDF  
Wood

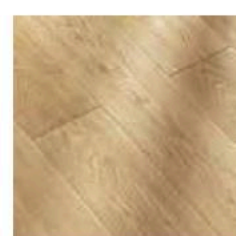

Walls  
Porcelain Tiles

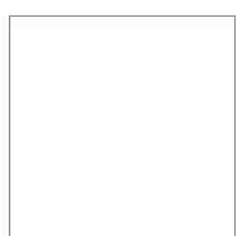

Ceiling  
Paint White  
Color



Lighting

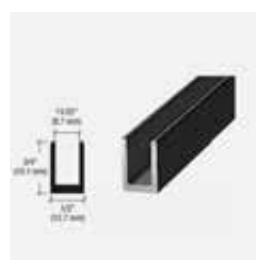

Horizontal Aluminum U-Channel  
Between walls and skirting termination  
CRL SDCD516MBL Matte Black 5/16" Single Aluminum  
UChannel

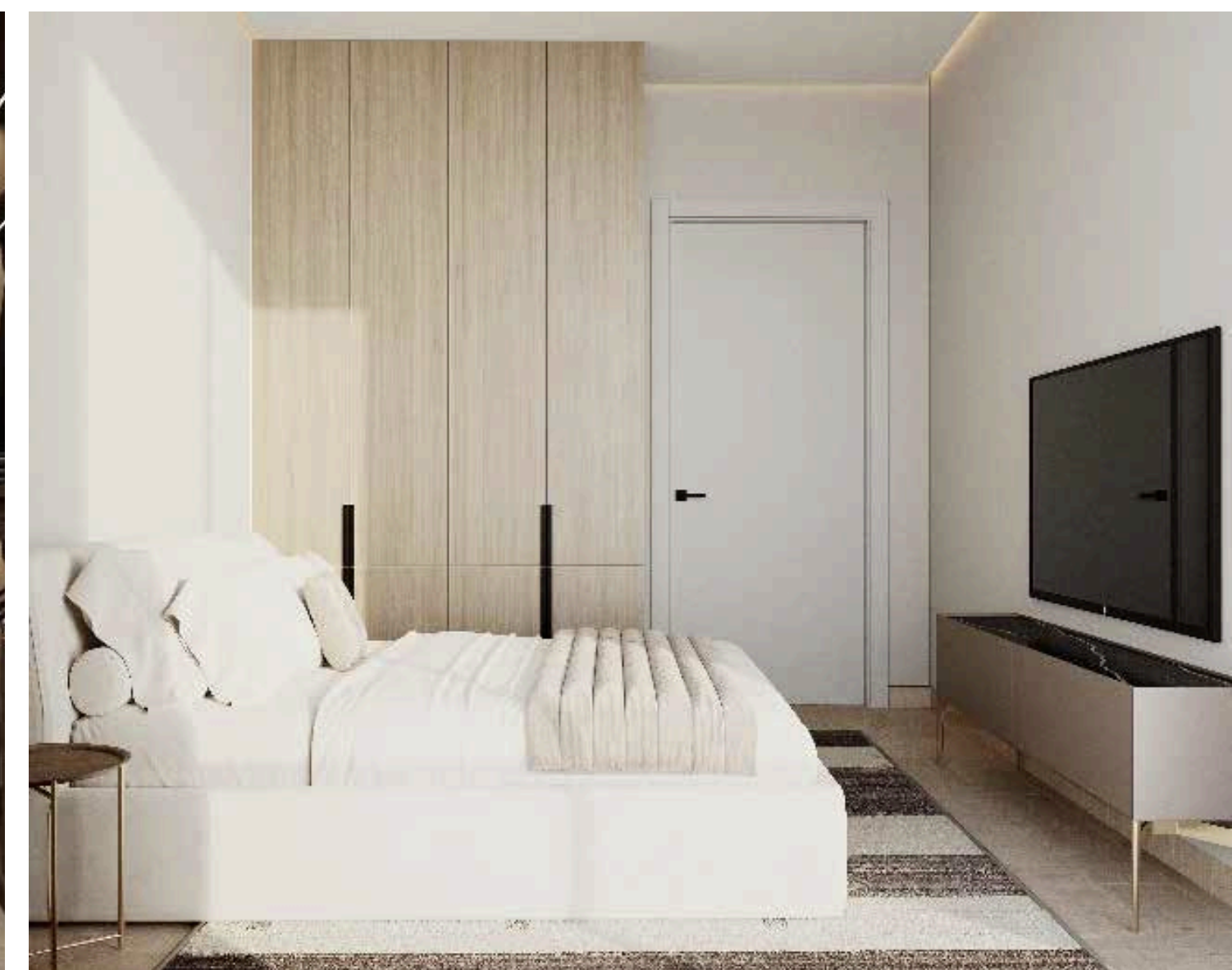

*Exterior*







EW

EDGEWATER  
RESIDENCES

P





# Outdoor amenities



Kids pool



Seating promenade



Overflow pool



Table tennis



Outdoor gym



Yoga space



Playground



Quiet zone



Jogging track



Padel court



# Indoor amenities



Kids playing room



Gym



Common room



# Building

3 towers | 12 residential floors per each | 2 podium floors

Premium collection of semi fitted apartments with high-quality **BOSCH** kitchen appliances. Top-floor apartments will offer stunning sea views and golf courses from the 5th floor.



# Unit Types

## 1 BR Apartment

from 646 to 1,477 sq.ft — Starting Price **1,68M AED**

---

## 2 BR Apartment

from 1,081 to 2,162 sq.ft — Starting Price **2,50M AED**

---

## 3 BR Apartment

from 1,533 to 3,576 sq.ft — Starting Price **3,25M AED**

HANDOVER:

**Q4 2026**

# Payment plan

35/65

5%

Booking  
Mar-25

10%

1st Installment  
60 days

5%

2nd Installment  
Sep-25

10%

3 Installment  
Dec-25

5%

4th Installment  
Mar-26

65%

Handover  
Dec-26

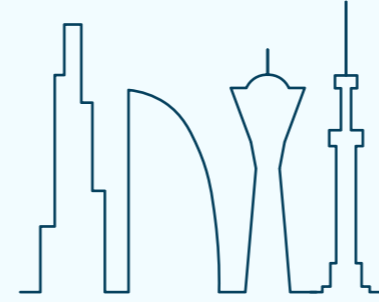

**PREFERENCE**  
properties

**PREFERENCE properties**

[info@preference.ae](mailto:info@preference.ae)

Phone: +971509792375

WhatsApp: +971509792375

<https://preference.ae/>